



## Communication unit for IP systems

FA01401-EN

CE

FC

ERC

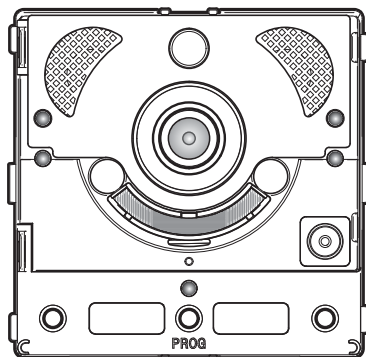
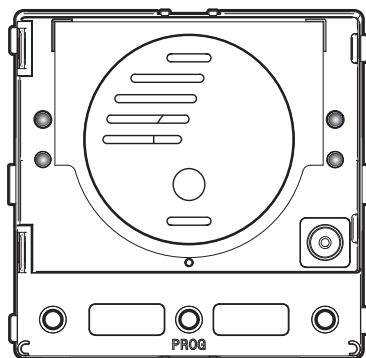

**MTMA/IP - MTMV/IP**

**PROGRAMMING MANUAL**

EN English

## General warnings

- ⚠ Important personal safety instructions: READ CAREFULLY!
- Installation, programming, commissioning and maintenance must only be performed by qualified and experienced personnel in compliance with applicable regulations.
- Wear antistatic shoes and clothing if working on the control board.
- Keep hold of these warnings.
- Always disconnect the electrical power supply during cleaning or maintenance.
- This product should only be used for the purpose for which it was explicitly designed. Any other use is considered dangerous.
- The manufacturer declines all liability for any damage as a result of improper, incorrect or unreasonable use.
- This device complies with Part 15 of the FCC Rules. Operation is subject to the following two conditions:
  - 1 - This device may not cause harmful interference.
  - 2 - This device must accept any interference received, including interference that may cause undesired operation.

MTMA/IP

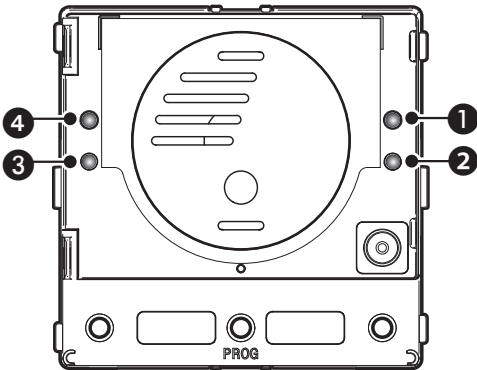

MTMV/IP

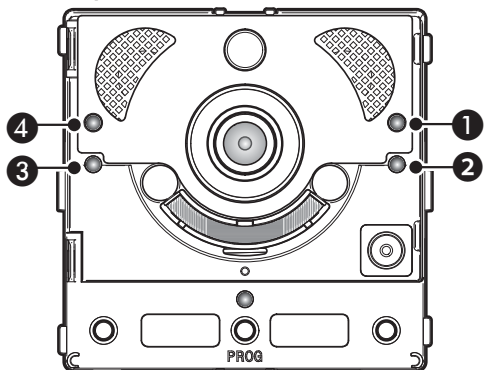

## Description of LEDs

- ① Yellow LED - Conversation in progress.
- ② Green LED - Door open.
- ③ Blue LED - System busy.
- ④ Red LED - Call in progress.

## Error alerts

■ LED on, LED flashing, □ LED off

Problem	Red	Green	Yellow	Blue	Possible causes
High temperature		□	□	□	Incorrect installation, near heat sources, hardware failure
Ethernet connection	■		□	□	CAT5 cable interrupted or not connected, incorrect DATA connection, switch not connected, faulty Ethernet port
Error in configuration data	■	□		□	Incorrect configuration, partial or incomplete programming
Audio or video service unavailable, SIP registration failed	■			□	Server cannot be reached or is switched off, incorrect SIP account

## Configuration and commissioning via WEB interface and PCS/XIP

Assign your PC an address belonging to the same subnet as the device. The default IP address is 192.168.1.5 with netmask 255.255.255.0.

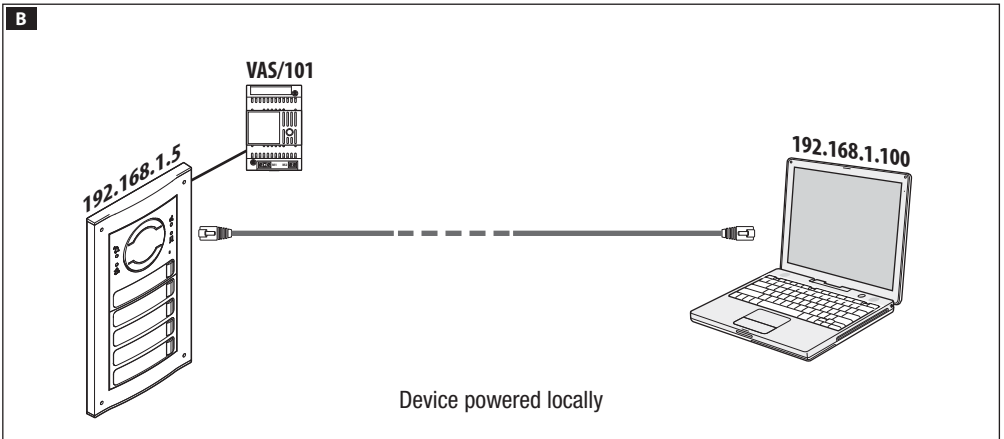
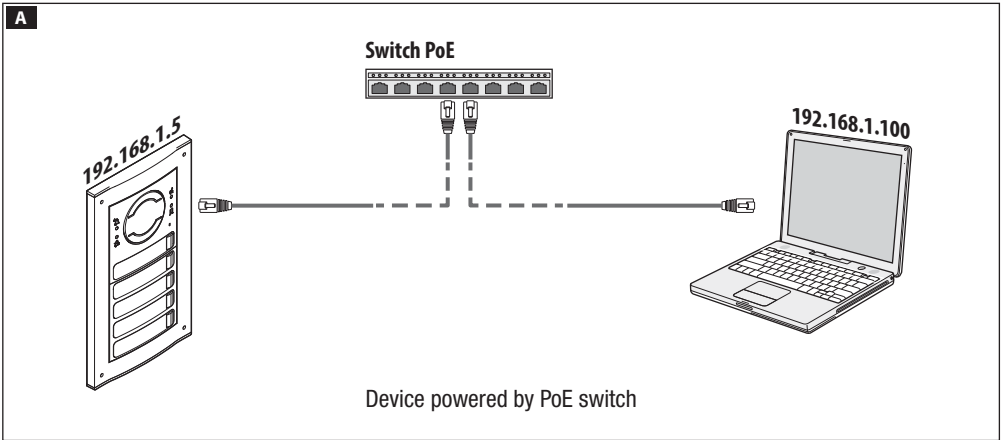

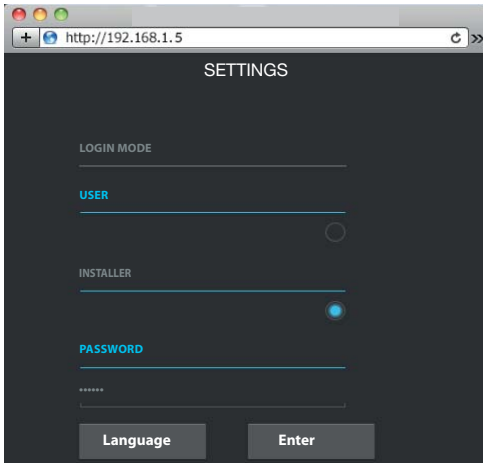

To access the configuration web page, enter the address of the device to configure in the browser (Chrome, Firefox, Safari) address bar.

On the [SETTINGS] page, in [LOGIN MODE], choose [INSTALLER] and enter the password [112233].

In [USER] login mode (default password: 123456) you can:

- 1) consult the pages that follow.
- 2) update the firmware.

On the configuration web pages, there is no scroll bar on the right. To scroll through web pages, press and hold the left-hand mouse button and drag. On your smartphone or tablet, use your finger to drag on the screen.

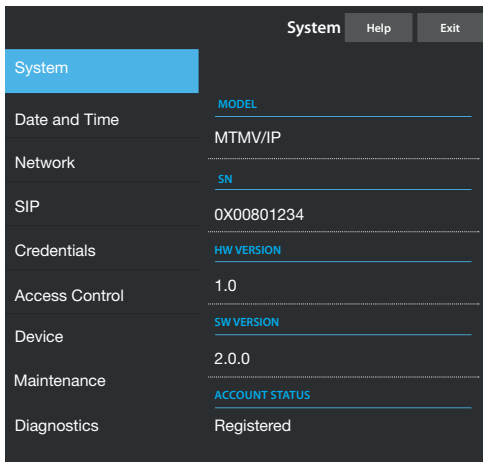

## System

Technical information identifying the characteristics of the device, the hardware and software versions and the SIP account status.

**N.B. The MTMV/IP, MTMA/IP can be configured as MASTER from PCS/XIP for 'Serverless' systems. Only one MTMV/IP, MTMAIP can be configured as MASTER.**

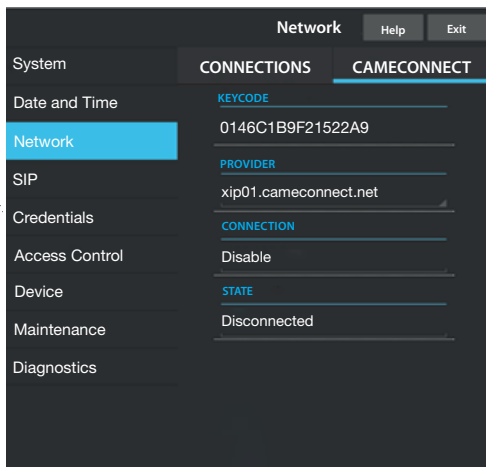
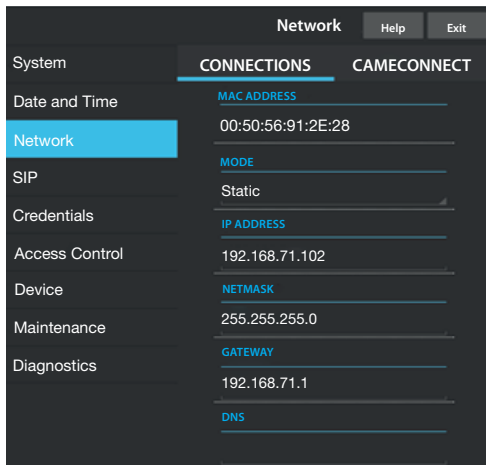

## Network

### [CONNECTIONS]

#### [MAC ADDRESS]

MAC ADDRESS of the device - cannot be changed

#### [MODE]

This allows you to choose the type of addressing from: DHCP the device's IP address is assigned by the DHCP server (for future use); **STATIC** (default), the device's IP address is assigned manually.

#### [IP ADDRESS]

If you have chosen to use a static IP, enter the IP address of the device, which must belong to the same subnet as the router and the other devices connected (default address: 192.168.1.5).

#### [NETMASK]

If different from the default, specify the subnet mask.

#### [GATEWAY]

Specify the default gateway for the home network.

#### [DNS]

Enter a valid DNS address if you want to enable the CAMEConnect connection (only on MTMV/IP, MTMA/IP configured as MASTER).

To save changes made or reload the previous data, press the button that will appear at the bottom of the page.

### [CAMECONNECT] only for devices configured as MASTER

Section for configuring the remotisation parameters.

[KEYCODE]: unique device code

[PROVIDER]: (default xip01.cameconnect.net) service URL for remote calls

[CONNECTION]: allows you to enable or disable VoIP remotisation of the video entry system call

[STATE]: indicates the connection status

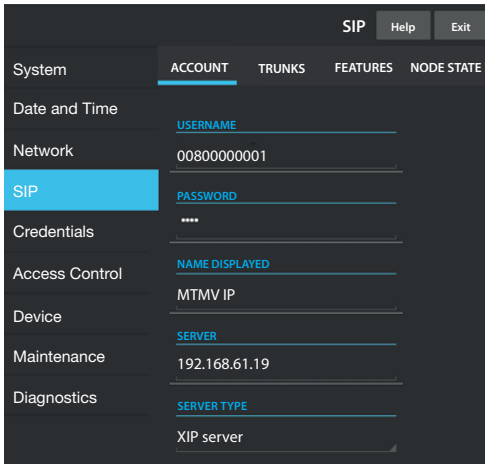

## SIP

### [ACCOUNT]

For a NON MASTER device, only this section appears

[USERNAME]: SIP username assigned by PCS/XIP to the device.

[PASSWORD]: (for future use).

[NAME DISPLAYED]: username assigned by PCS/XIP to the device.

[SERVER]: server IP address assigned by PCS/XIP

[SERVER TYPE]: (for future use)

If the configuration is correct and the SIP server is active, on the [SYSTEM] page, the [ACCOUNT STATUS] heading will show [REGISTERED].

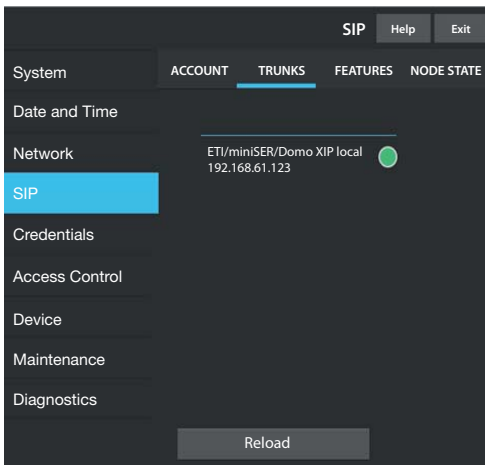

[TRUNKS] only for devices configured as MASTER

List of servers present in the system.

The icon on the right indicates whether the device and relative subsystem can be reached (green) or cannot be reached (red).

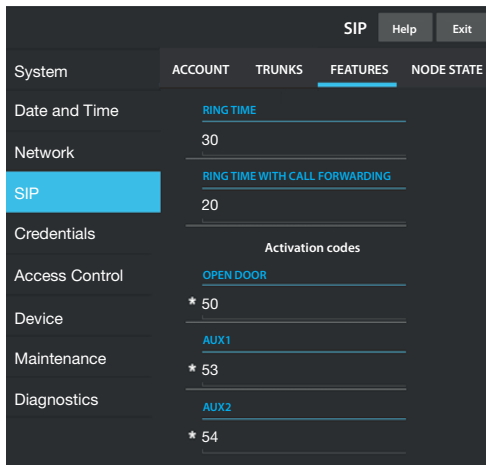

**[FEATURES]** only for devices configured as MASTER

**[RING TIME]:** ring time after which the user called will be considered absent.

**[RING TIME WITH CALL FORWARDING]:** ring time, with call forwarding on CameConnect active, after which the user called will be considered absent and forwarding will be activated.

In the **[ACTIVATION CODES]** section, you can see and edit the numerical DTMF codes assigned to the Door Opener, Aux1 and Aux2 commands.

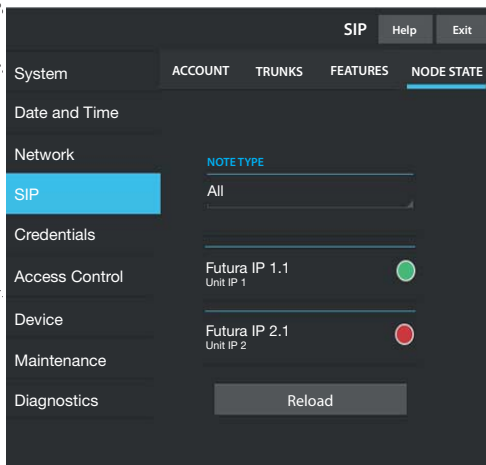

**[NODE STATE]** only for devices configured as MASTER

List of system SIP VoIP devices and their registration status in relation to the MTMV/IP, MTMA/IP MASTER entry panel.

Green: registered device  
Red: non-registered device.

Under the heading **[NOTE TYPE]**, you can filter the list of devices by type.

**CREDENTIALS** Help Exit

System LICENSES XIP RECEIVERS XIP MOBILE GENERIC SIP

Date and Time

Network

SIP

**Credentials**

Access Control

Device License request

Maintenance

Diagnostics License Upload

UNIT	DESCRIPTION	CREATION	INSERTION	QTY
APP	XIPMakeLic mobile app UA license	2016-05-13 12:45:20	2016-05-18 7:45:20	5

DESCRIPTION

Request

FILE NAME

No license file selected

## Credentials

### [LICENSES]

List of licenses entered and available (for MTMV/IP, MTMA/IP MASTER only). By default, each MTMV/IP, MTMA/IP MASTER entry panel has 4 licenses included, which can be used as both APP and GST licenses.

Select **[REQUEST]** to obtain the device identification data needed to apply for additional licenses.

Any string included under the **[DESCRIPTION]** heading is added to the device identification file.

In the **[UPLOAD LICENSE]** section, it is possible to add the additional licenses required: press **[UPLOAD]** and select the file with the licenses to upload to the device (for MASTER devices only).

**CREDENTIALS** Help Exit

System LICENSES XIP RECEIVERS XIP MOBILE GENERIC SIP

Date and Time

Network

SIP



**Credentials**

Access Control

Device

Maintenance

Diagnostics

UNIT	DESCRIPTION	SIP USERNAME
Unit IP 1	Futura IP 1.1	00401200256 
Unit IP 2	Futura IP 2.1	00401201258 
IP Unit 3	Futura IP 3.1	00401200256 

**[XIP RECEIVERS]** only for devices configured as MASTER

List of XIP type devices (SIP receivers), which do not require a license and use the MTMV/IP, MTMA/IP MASTER entry panel as the registration server.

**[UNIT]:** unit to which the receiver belongs

**[DESCRIPTION]:** receiver description as configured by PCS/XIP.

**[SIP USERNAME]:** SIP username assigned by PCS/XIP to the XIP receiver. The SIP username and password must be configured in the receiver so that this registers them in the MTMV/IP, MTMA/IP entry panel.

Press  to change the receiver SIP account password.



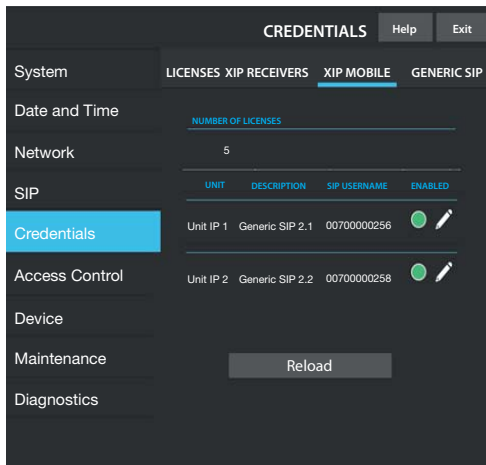

**[XIP MOBILE]** only for devices configured as MASTER

List of XIPMobile type devices, which require a license and use the MTMV/IP, MTMA/IP MASTER entry panel as the registration server.

**[NUMBER OF LICENSES]:** number of licenses still available.

**[UNIT]:** unit to which the XIPMobile device belongs.

**[DESCRIPTION]:** device description as configured by PCS/XIP.

**[SIP USERNAME]:** SIP username assigned by the XIP-Mobile app. The SIP username and password must be configured in the XIPMobile app so that this registers them in the MTMV/IP, MTMA/IP entry panel.

**[ENABLED]:** if the icon is green, the account is enabled for registration in the MTMV/IP, MTMA/IP entry panel. If the icon is red, this indicates that the account is not enabled for registration.

Select  to enabled or disable the account and to change the password.

Each enabled account needs an App license, which is subtracted from the total number of licenses available.

**[GENERIC SIP]** only for devices configured as MASTER

List of SIP type devices, which require a license and use the MTMV/IP, MTMA/IP MASTER entry panel as the registration server.

**[NUMBER OF LICENSES]:** number of licenses still available.

**[UNIT]:** unit to which the generic SIP device belongs.

**[DESCRIPTION]:** device description as configured by PCS/XIP.

**[SIP USERNAME]:** SIP username assigned by PCS/XIP. The SIP username and password must be configured in the SIP device so that this registers them in the MTMV/IP, MTMA/IP entry panel.

**[ENABLED]:** if the icon is green, the account is enabled for registration in the MTMV/IP, MTMA/IP entry panel. If the icon is red, this indicates that the account is not enabled for registration.

Select  to enabled or disable the account and to change the password.

Each enabled account needs an App license, which is subtracted from the total number of licenses available.

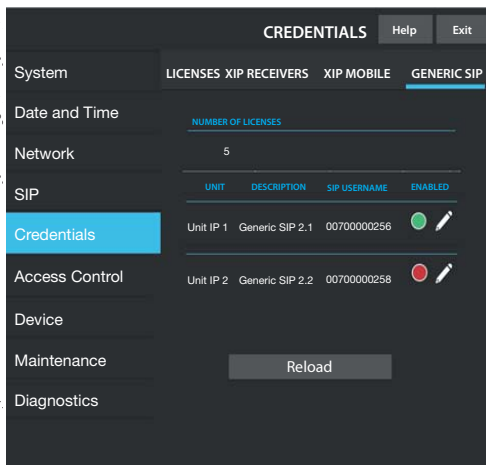

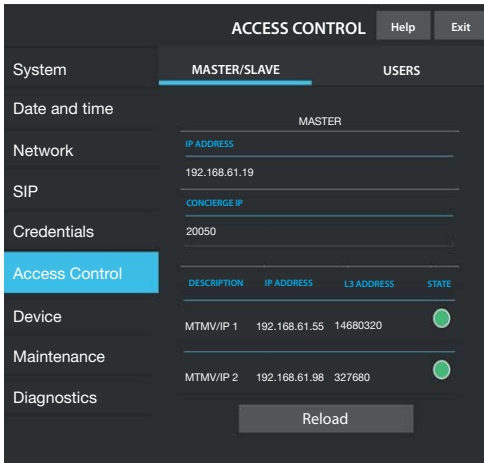

## Access control

### [MASTER/SLAVE]

**[IP ADDRESS]:** this is the MASTER device address. In the case of MTMV/IP, MTMA/IP MASTER, it is the address of the device itself.

**[IP PORT]:** (default 20050) this is the MASTER device port.

For MTMV/IP, MTMA/IP MASTER entry panels only, there is a list of SLAVE devices. The green icon indicates that the SLAVE device is connected to the MASTER device. The red icon indicates that the SLAVE device is not connected to the MASTER device.

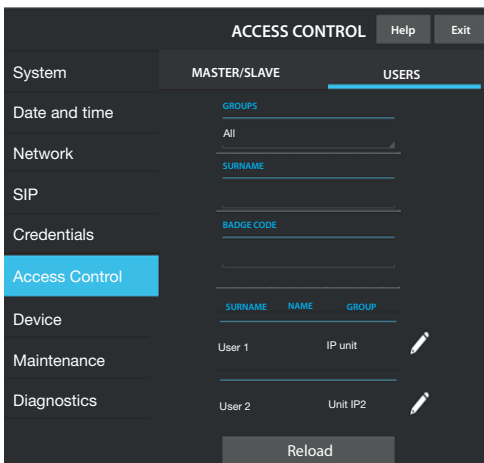

### [USERS]

The access control users are listed under this heading.

Under the heading **[GROUP]**, you can select a group of users to view.

**[SURNAME]:** to search by surname, select **[RELOAD]**.

**[BADGE CODE]:** to search by badge code, select **[RELOAD]**.

The search results appear at the bottom of the page.

From a MASTER device, select ✎ by a user to change status (active or non active), the badge code or numeric access code.

The authorisations for routes and openings are defined by PCS/XIP.



## Device

### [AUDIO/LED]

You can change the volume of the speaker, the microphone (only if really needed, for example in special environmental conditions) and the backlighting of the entry panel keys.

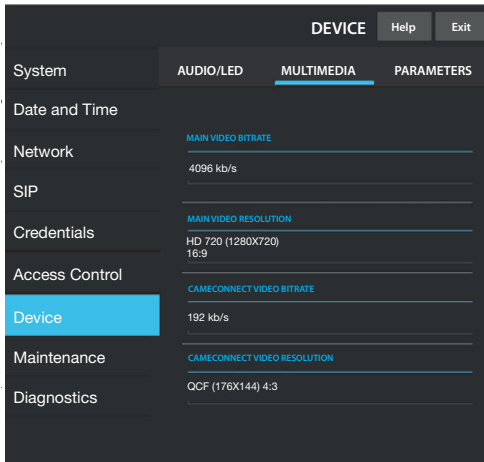

### [MULTIMEDIA]

You can configure the maximum BITRATE and RESOLUTION of the video STREAM that the entry panel can transmit from the available values.

The higher the BITRATE and RESOLUTION values, the better the video quality, but also the higher the occupation of the data band in UPLINK.

You can configure two profiles:

**MAIN** this is the profile used for communications with local devices in the system;

**CAMECONNECT** this is the profile used for communications to XIPMobile devices connected remotely on CameConnect.

The BITRATE and RESOLUTION of the CAMECONNECT profile should be selected according to the available UPLINK band.

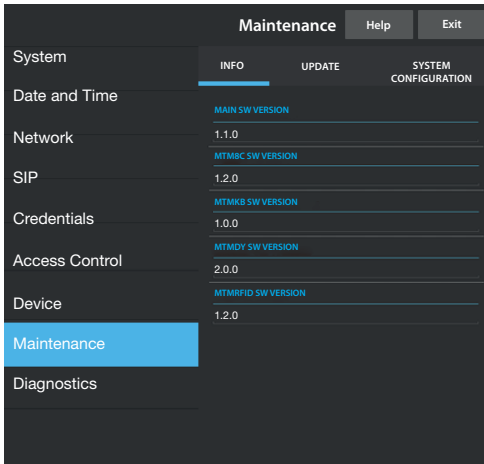

## Maintenance

[INFO] to display the firmware version of the main module and connected accessories.

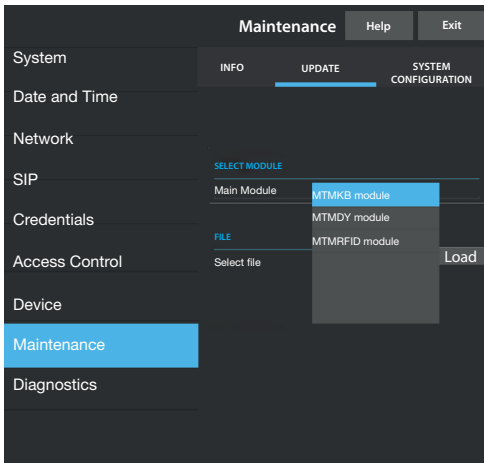

[UPDATE] for the firmware of the connected devices. Press [SELECT MODULE] to choose which module to update, and select the firmware update file from your PC. Start the process.

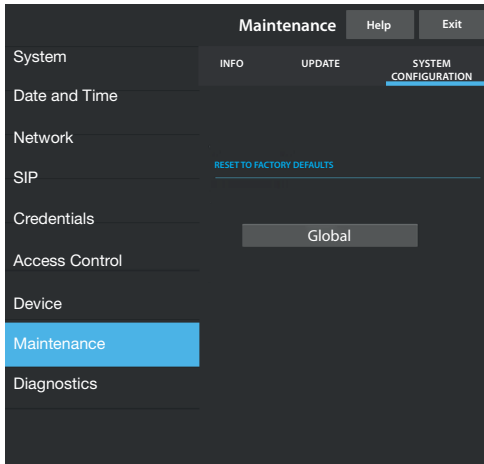

[SYSTEM CONFIGURATION] restore the default settings for the main module and connected accessories by choosing [GLOBAL].

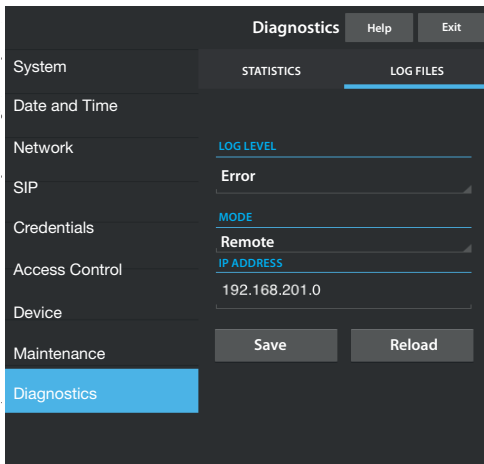

## Diagnostics

### [STATISTICS]

Statistical data on device operation.

### [LOG FILES]

You can generate data files to identify the causes of faults.

[LOG LEVEL]: you can choose the accuracy and type of LOG file.

[MODE]: you can choose the location for saving the LOG file including:

[Local-RAM]: the file is saved in the device's non-permanent memory

[Local-FLASH]: the file is saved in the device's internal memory (capacity is limited)

[Remote]: the file is saved in a remote server

[IP ADDRESS]: specify the IP address of the remote server.

# Operations on PCS/XIP

The device is part of a system based on the Xip system. The system structure must be built using PCS/XIP software.

The screenshot displays the PCS/XIP software interface with two main panes: 'Device view' and 'Unit view'.

**Device view (Left Pane):** Shows a hierarchical tree structure under 'XIP Multi server'. The 'Main MTMV IP' is selected and highlighted with a blue bar and a circled '2'. Other visible items include 'Built-in buttons', 'Aux', 'MTM8C', 'Main MTMA IP', 'IP block 1', 'IP sub block', 'Unit IP 1-4', and 'Block MTMV IP'.

**Unit view (Right Pane):** Shows the configuration for the selected 'Main MTMV IP' device. The 'Devices' list on the left includes 'Server', 'ETI/miniSER/Domo XIP', 'DVC IP', 'DC IP', 'MTMV IP' (circled '1'), 'MTMA IP', 'Area', and 'Concierge'. The 'MTMV IP properties' section (circled '3') contains the following configuration:

- Name: Main MTMV IP
- Address: 224.4.0
- ID: 111111 (circled '4')
- Addressing mode: Static
- IP address: 192.168.1.3 (circled '5')
- Talk time (s): 60
- Ring time (s): 30
- SIP username: 008000, 01024
- Door opening time (s): 2
- Twilight indicated by: <None>
- Door open alarm time (s): Inactive
- Door open contact: Normally open (NO)
- Lift management aux: No event
- Door opener entry notification: Disabled (default)
- Customise the use of tones:
- Door status: Door status (default)
- Plate active: Plate active (default)

The screenshot displays a software interface for configuring a system. It is divided into two main sections: 'Device view' and 'Unit view'.

**Device view (Left):** Shows a hierarchical tree structure of the system. The selected device is 'Block MTMV IP (Master)', which is highlighted in blue. Other visible components include 'Serverless IP plate', 'Main MTMV IP', 'Main MTMA IP', 'IP block', 'IP sub block', 'Unit IP 1-4', 'Block MTMA IP', and 'MTM8C'.

**Unit view (Right):** Shows the configuration properties for the selected 'Block MTMV IP (Master)'. The 'MTMV IP properties' section includes the following fields:

- Name:** Block MTMV IP
- Address:** 224.1.0
- ID:** 333333
- Addressing mode:** Static
- IP address:** 192.168.1.7
- Talk time (s):** 60
- Ring time (s):** 30
- Ring time with call forw. (s):** 20
- Save system backup**
- SIP username:** 008000 00256
- Door opening time (s):** 2
- Twilight indicated by:** <None>
- Door open alarm time (s):** Inactive
- Door open contact:** Normally open (NO)
- Lift management aux:** No event
- Door opener entry notification:** Disabled (default)
- Customise the use of tones**
- Door status:** Door status (default)
- Plate active:** Plate active (default)

Create the system structure as required: to insert the IP entry panels, drag the MTMV IP modules for video or MTMA IP for audio only from the list on the right ①. Select the devices ② inserted and complete the properties ③; the following fields are mandatory: ID ④ and IP Address ⑤. Add the accessory modules, for example the MTM8C button module ⑥, define its layout and set the calls corresponding to each key.

Complete the configuration of the other devices and proceed with system programming.

**Regulatory references** The product complies with the applicable reference directives.

**Dismantling and disposal.** Dispose of the packaging and the device properly at the end of its life cycle, according to the regulations in force in the country where the product is used. The recyclable components bear the symbol and code for the material.

THE DATA AND INFORMATION PROVIDED IN THIS MANUAL ARE SUBJECT TO CHANGE AT ANY TIME WITHOUT PRIOR NOTICE. MEASUREMENTS, UNLESS OTHERWISE INDICATED, ARE IN MILLIMETRES.

**CAME**   
**BPT**

[CAME.COM](http://CAME.COM)

**CAME S.P.A.**

Via Martiri Della Libertà, 15

31030 Dosson di Casier - Treviso - Italy

tel. (+39) 0422 4940 - fax. (+39) 0422 4941